



INSTALLATION

PIONEER INDUSTRIES, INC.
 3325 S. Garfield Ave.
 Commerce, CA 90040
 (800) 338-9468
 www.pioneerind.com

Tools:



Adjustable Wrench



Plumbers Putty



Teflon Tape



Rags

Model Number: 3MO160, 3MO180, 3MO168, 3MO160-WD, 3MO180-WD

Warnings and Notes:

Check with local plumbing code requirements before installation.
 This product should be installed by a local listed plumber.
Do not use plumbers putty on threads.



Installation Steps:

Single Handle Lavatory Faucet

Pop-up Drain Installation:

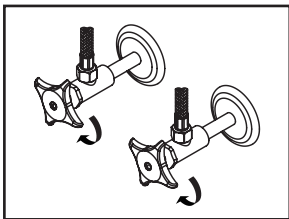

(1) Shut off water supplies. Remove old faucet. Clean mounting surface in preparation for new faucet.

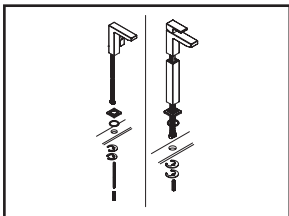

(2a) **For 1-Hole Installation:-** Install mounting bolt.
For 3MO168 :- Install mounting bolt. Place 8" extension and align it.
For Both:- Place escutcheon with gasket under the faucet then place faucet in position on the sink. Slide mounting washer and mounting plate through mounting bolt from underneath of the sink, tighten locknut to mounting bolt.

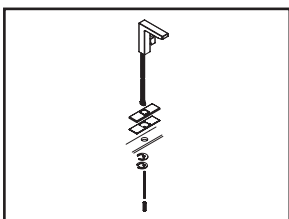

(2b) **For 3-Hole Installation:-** Install mounting bolt. Place deck plate with gasket under the faucet then place faucet in position on the sink. Slide mounting washer and mounting plate through mounting bolt from underneath of the sink, tighten locknut to mounting bolt.

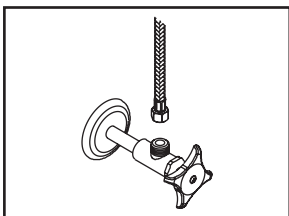

(3) Connect hot and cold inlet supply hoses to supply stops. For 1/2" connection; use 3/8" male to 1/2" female adapter for installation. Adapters are optional and not provided with the faucet.

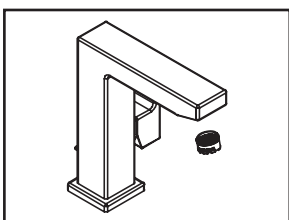

(4) Important: After installation is complete, remove aerator. Turn water supplies on and allow both hot and cold water to run at least one minute each. While water is running, check for leaks. Turn off water and replace aerator.

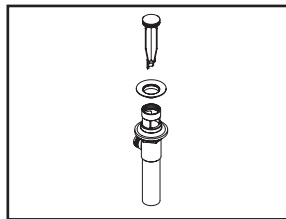

(1) Remove pop-up flange from body

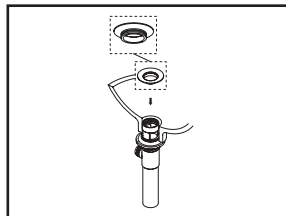

(2) Place a ring of plumbers putty on the bottom of flange.

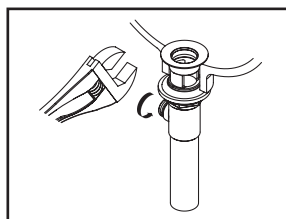

(3) Insert pop-up flange through drain hole and attach flange to body. Use Teflon tape to thread tail piece to Pop-up drain body. Ensure the pop-up outlet faces towards the back of the sink. Tighten the locknut securely with a wrench. Do not overtighten.

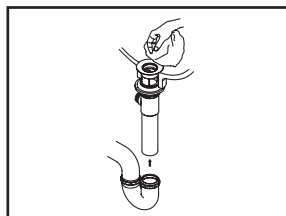

(4) Remove the excess plumbers putty. Connect the trap (check manufacturer's instructions for installation).

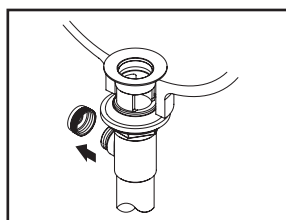

(5) Remove pivot rod nut from pop-up body, ensure the washers is in place, insert pivot rod, tighten pivot rod nut back to pop-up body.

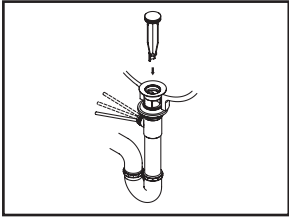

(6) Push pivot rod down, insert drain plug carefully. Test to ensure drain plug works properly.

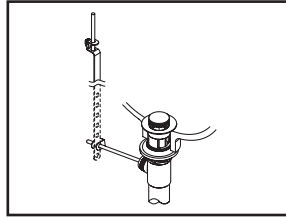

(7) Connect lift rod strap to pivot rod by using clip. Tighten the thumbscrew to connect lift rod strap to pop-up lift rod.

Exploded Drawing (3MO160):

* Note: Please specify finish/color when ordering.

	ITEM #	DESCRIPTION
A	X-1300019*	Metal Lever Handle
B	X-4300088*	Cap
C	X-4300089	Locknut
D	X-3300006	Ceramic Disc Cartridge
E	OP-490062	1.2 GPM Aerator & Tool
F	X-4300091*	Escutcheon
G	X-5300012	Mounting Kit
H	X-6300029*	Pop-Up Drain Assembly
I	X-4300087*	Deck Plate (For 3MO160-WD)
1	X-4900044*	Hole Cover
2	X-4400099	Allen Screw

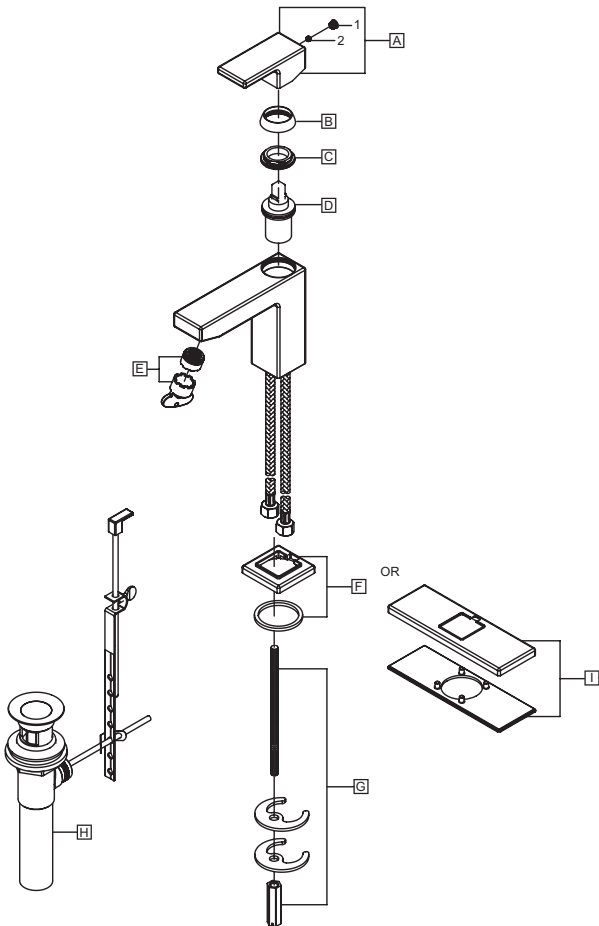

Exploded Drawing (3MO180):

* Note: Please specify finish/color when ordering.

	ITEM #	DESCRIPTION
A	OP-490062	1.2 GPM Aerator & Tool
B	X-3300007	Ceramic Disc Cartridge
C	X-4300089	Locknut
D	X-4300088*	Cap
E	X-1300019*	Metal Lever Handle
F	X-4300091*	Escutcheon and Washer
G	X-5300012	Mounting Kit
H	X-6300029*	Pop-Up Drain Assembly
I	X-4300087*	Deck Plate (For 3MO180-WD)
1	X-4900044*	Hole Cover
2	X-4400099	Allen Screw

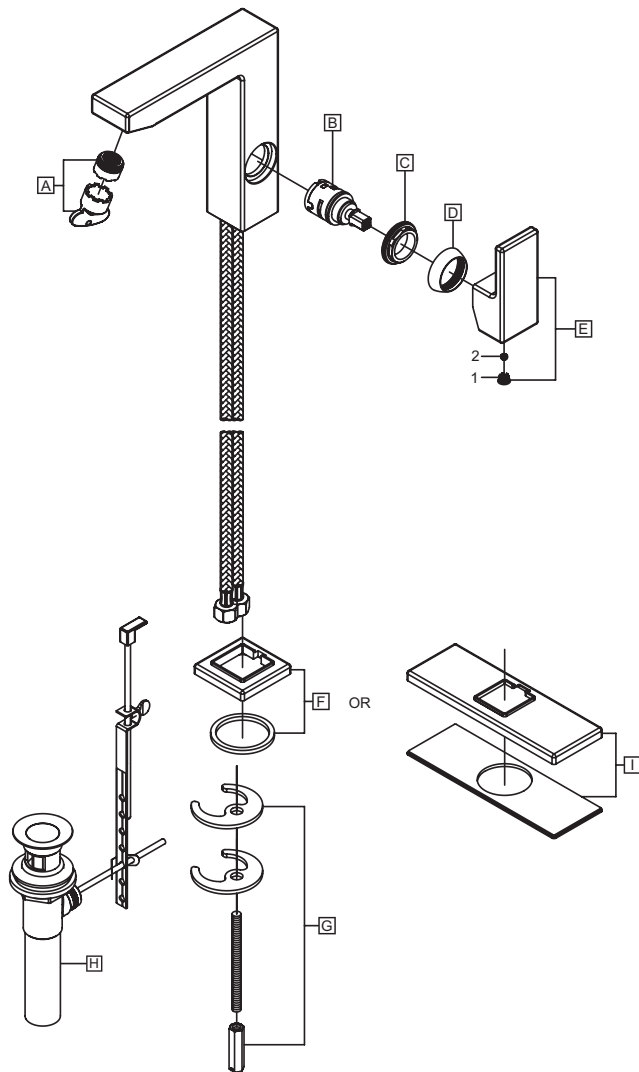

Exploded Drawing (3MO168):

* Note: Please specify finish/color when ordering.

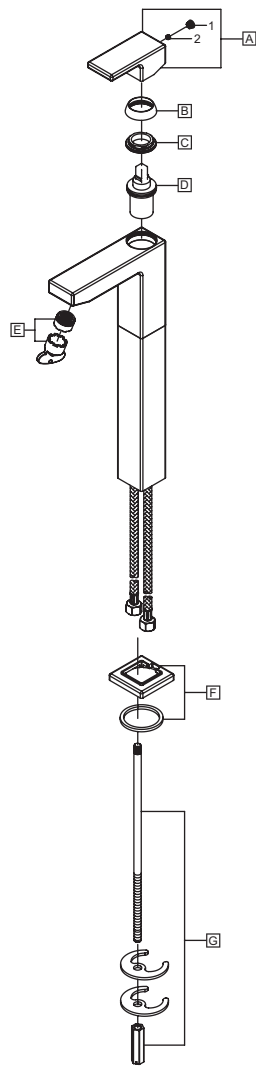

	ITEM #	DESCRIPTION
A	X-1300019*	Metal Lever Handle
B	X-4300088*	Cap
C	X-4300089	Locknut
D	X-3300006	Ceramic Disc Cartridge
E	OP-490062	1.2 GPM Aerator & Tool
F	X-4300091*	Escutcheon and Washer
G	X-5300008	Mounting Kit
1	X-4900044*	Hole Cover
2	X-4400099	Allen Screw



For more care information or trouble shooting inquiries
 about your Pioneer product, please call:
Pioneer Industries, Inc. (800) 338-9468
 Monday-Friday 8 AM to 8 PM EST (5 AM to 5 PM PST)
www.pioneerind.com